



Driver LC 38W 350-500mA flexC Ip ADV

advanced series non-SELV

Product description

- Built-in constant current LED Driver
- New version DC operating with EL marking
- For luminaires of protection class I and protection class II
- Temperature protection as per EN 61347-2-13 C5e
- Adjustable output current between 350 and 500 mA
- Max. output power 38 W
- Up to 88 % efficiency
- Nominal life-time up to 100,000 h
- 5-year guarantee



Housing properties

- Low-profile metal casing with white cover
- Type of protection IP20



Interfaces

- Terminal blocks: 45° push terminals

Functions

- Overload protection
- Short-circuit protection
- No-load protection
- Burst protection voltage 1 kV
- Surge protection voltage 1 kV (L to N)
- Surge protection voltage 2 kV (L/N to earth)
- Suitable for emergency lighting systems acc. to EN 50172

Typical applications

- For linear/area lighting in office applications

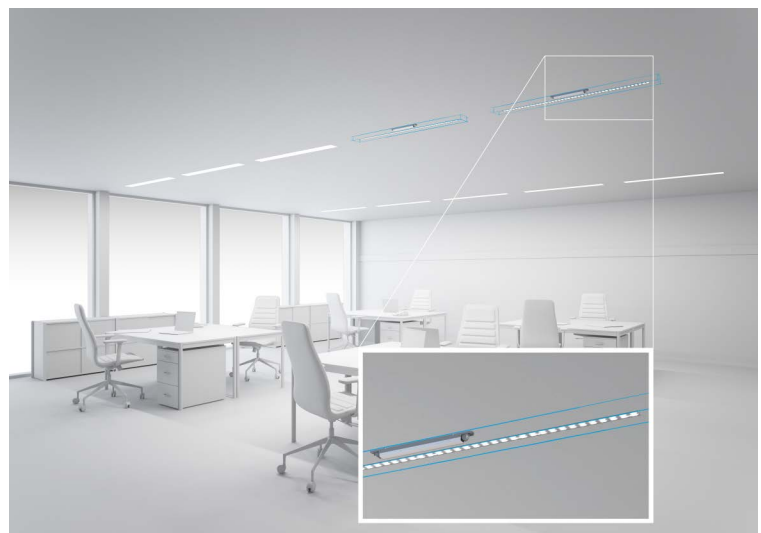

Standards, page 4

Wiring diagrams and installation examples, page 4

IP20 

Driver LC 38W 350-500mA flexC Ip ADV

advanced series non-SELV

Technical data

Rated supply voltage	220 – 240 V
AC voltage range	198 – 264 V
DC voltage range	176 – 280 V
Max. input current (at 230 V, 50 Hz, full load)	0.2 A
Typ. input current (at 230 V, 0 Hz, full load)	0.2 A
Leakage current (at 230 V, 50 Hz, full load)	< 450 µA
Mains frequency	0 / 50 / 60 Hz
Overvoltage protection	320 V AC, 48 h
Max. input power	42.5 W
Typ. power consumption (at 230 V, 50 Hz, full load)	42.2 W
Min. output power	12.3 W
Max. output power	38 W
Typ. efficiency (at 230 V / 50 Hz / full load) ^①	88 %
λ (at 230 V, 50 Hz, full load) ^②	0.95
Output current tolerance ^③	± 7.5 %
Max. output current peak ^③	≤ output current + 10 %
Max. output voltage	250 V
THD (at 230 V, 50 Hz, full load)	< 20 %
Output LF current ripple (< 120 Hz)	± 5 %
Starting time (at 230 V, 50 Hz, full load)	≤ 500 ms
Starting time (DC mode)	< 1,000 ms
Switchover time (AC/DC) ^④	< 500 ms
Turn off time (at 230 V, 50 Hz, full load)	≤ 0.5 s
Hold on time at power failure (output)	0 s
Ambient temperature ta (at life-time 100,000 h)	40 °C
Storage temperature ts	-40 ... +80 °C
Life-time	up to 100,000 h
Dimensions L x W x H	280 x 30 x 21 mm
Hole spacing D	268 mm

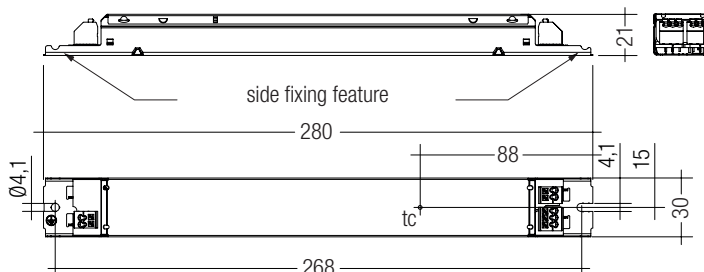

Ordering data

Type	Article number	Packaging, carton	Packaging, pallet	Weight per pc.
LC 38W 350-500mA flexC Ip ADV	28002466	50 pc(s).	900 pc(s).	0.163 kg

Specific technical data

Type	Output current ^②	Min. forward voltage	Max. forward voltage	Max. output power	Typ. power consumption (at 230 V, 50 Hz, full load)	Typ. current consumption (at 230 V, 50 Hz, full load)	Max. casing temperature tc	Ambient temperature ta max.	I-out select	Resistor ^⑤
LC 38W 350-500mA flexC Ip ADV	350 mA	35 V	75 V	26.3 W	30.4 W	136 mA	70 °C	-20 ... +55 °C	0-2	ADV Type A
	375 mA	35 V	75 V	28.1 W	32.9 W	147 mA	70 °C	-20 ... +50 °C	0-2	ADV Type B
	400 mA	35 V	75 V	30.0 W	34.0 W	152 mA	70 °C	-20 ... +50 °C	0-1	ADV Type A
	450 mA	35 V	75 V	33.8 W	39.4 W	175 mA	70 °C	-20 ... +50 °C	0-2	ADV Type C
	500 mA	35 V	75 V	37.5 W	42.3 W	187 mA	70 °C	-20 ... +50 °C	open	-

^① Test result at 500 mA.

^② Output current is mean value.

^③ Test result at 25 °C.

^④ Type A is a short circuit plug (0 Ω).

^⑤ Valid for immediate change of power supply type otherwise the starting time is valid.

Product description

- Ready-for-use resistor to set output current value
- Compatible with LED Driver serie LC flexC ADV; not compatible with I-SELECT (generation 1) and I-SELECT 2 (generation 2)
- Resistor is base insulated
- When using your own resistors, make sure the resistor must be insulated
- Resistor power 0.25 W
- Current tolerance $\pm 2\%$ additional to output current tolerance
- Hot plug of the resistor is not permitted
- For detailed current setting see table "Specific technical data" of the respective LED Driver and chapter 3.8 Current setting

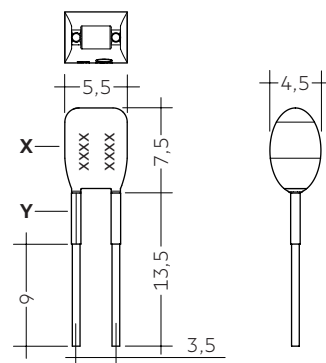

Ordering data

Type	Article number	Colour of X area	Colour of Y area	Marking	Resistor value	Packaging bag	Weight per pc.
ADV Plug Type A YL	28001771	Yellow	Yellow	A	0.0 Ω	10 pc(s).	0.001 kg
ADV Plug Type B YL	28001772	Yellow	Black	B	3.16 k Ω	10 pc(s).	0.001 kg
ADV Plug Type C YL	28001773	Yellow	Purple	C	28.7 k Ω	10 pc(s).	0.001 kg

1. Standards

EN 55015
EN 61000-3-2
EN 61000-3-3
EN 61347-1
EN 61347-2-13
EN 61547
EN 62384

According to EN 50172 for use in central battery systems
According to EN 60598-2-22 suitable for emergency lighting installations

2. Thermal details and life-time

2.1 Expected life-time

Expected life-time				
Type	ta	40 °C	50 °C	60 °C
LC 38W 350-500mA flexC Ip ADV	tc	60 °C	70 °C	x
	Life-time	100,000 h	50,000 h	x

The LED Driver is designed for a life-time stated above under reference conditions and with a failure probability of less than 10 %.

3. Installation / wiring

3.1 Circuit diagram

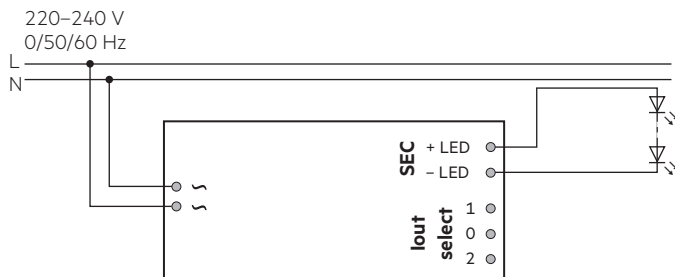

3.2 Wiring type and cross section

The wiring can be stranded wires with ferrules or rigid wires with a cross section of 0.5 – 1.5 mm². Strip 8.5 – 9.5 mm of insulation from the cables to ensure perfect operation of the push-wire terminals.

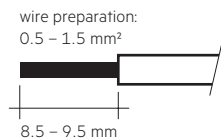

3.3 Release of the wiring

Press down the “push button” and remove the cable from front.

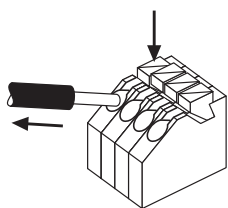

3.4 Installation instructions

The LED module and all contact points within the wiring must be sufficiently insulated against 3 kV surge voltage. Air and creepage distance must be maintained.

3.5 Wiring guidelines

- All connections must be kept as short as possible to ensure good EMI behaviour.
- Mains leads should be kept apart from LED Driver and other leads (ideally 5 – 10 cm distance)
- Max. length of output wires is 2 m.
- Incorrect wiring can damage LED modules.
- To avoid the damage of the Driver, the wiring must be protected against short circuits to earth (sharp edged metal parts, metal cable clips, louver, etc.).
- The current selection has to be installed in the accordance to the requirement of low voltage installation.

3.6 Replace LED module

1. Mains off
2. Remove LED module
3. Wait for 20 seconds
4. Connect LED module again

Hot plug-in or output switching of LEDs is not permitted and may cause a very high current to the LEDs.

3.7 Earth connection

The earth connection is conducted as protection earth (PE). The LED Driver can be earthed via metal housing. If the LED Driver will be earthed, protection earth (PE) has to be used. There is no earth connection required for the functionality of the LED Driver. Earth connection is recommended to improve following behaviour.

- Electromagnetic interferences (EMI)
- Transmission of mains transients to the LED output

In general it is recommended to earth the LED Driver if the LED module is mounted on earthed luminaire parts respectively heat sinks and thereby representing a high capacity against earth.

For Class I application, protection earth need to connected with the metal housing (bottom part).

For Class II application, protection earth is no need to be connected, below 2 scenarios should be considered:

- If the LED Driver housing is screw on a metal part inside the luminaires, both LED Driver and LED module must be insulated.
- If the LED Driver housing is screw on a plastic part inside the luminaires, the LED module need to be insulated.

3.8 Current setting

350 mA: Terminal 0 and 2 connected with 0 Ω wire (max. 6 cm length) or resistor ADV Plug Type A BR (article number: 28001771)

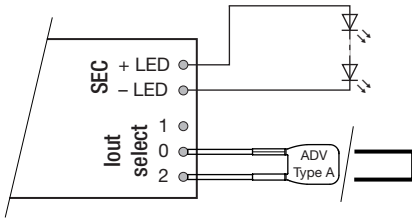

375 mA: Terminal 0 and 2 connected with resistor ADV Plug Type B BR (article number: 28001772)

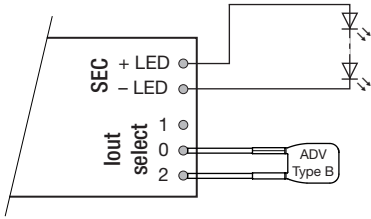

400 mA: Terminal 0 and 1 connected with 0 Ω wire (max. 6 cm length) or resistor ADV Plug Type A BR (article number: 28001771)

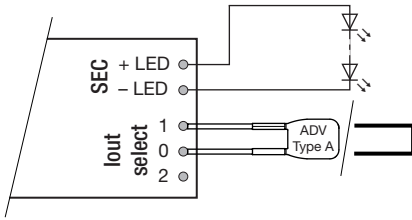

450 mA: Terminal 0 and 2 connected with resistor ADV Plug Type C BR (article number: 28001773)

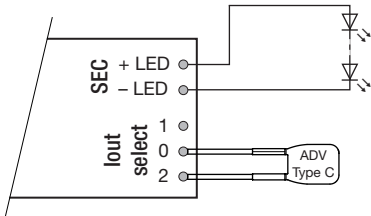

500 mA: All terminals open

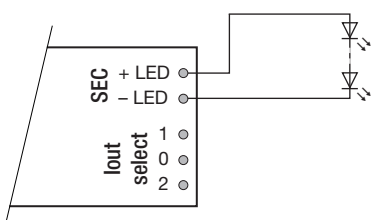

3.9 Mounting of device

Max. torque for fixing: 0.5 Nm/M4

4. Electrical values

Test at 230 V 50 Hz.

4.1 Efficiency vs load

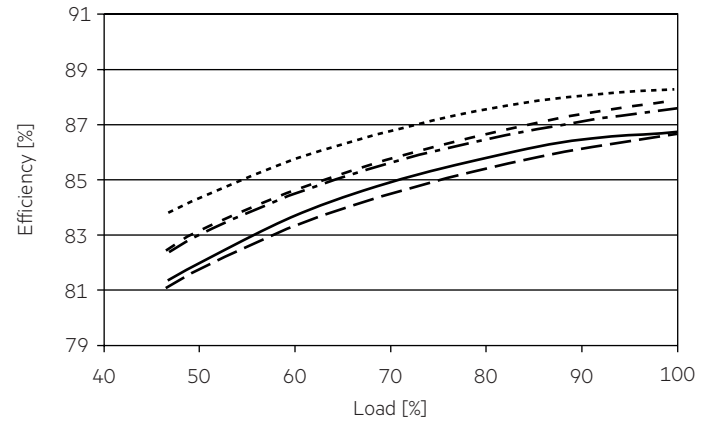

4.2 Power factor vs load

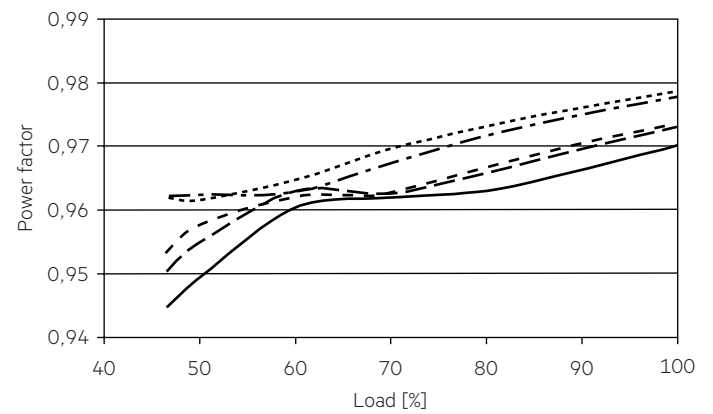

4.3 Input power vs load

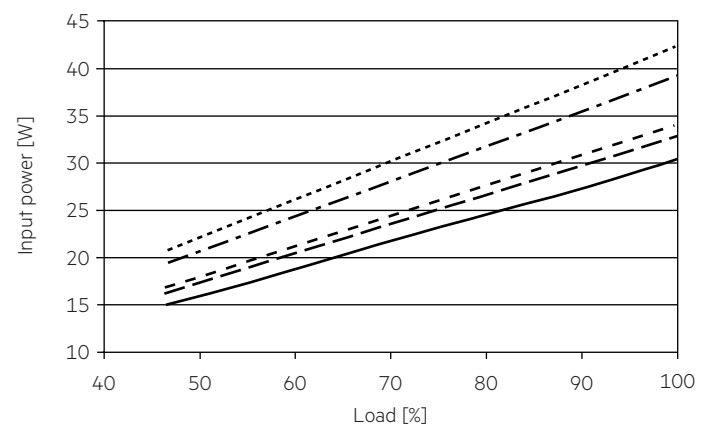

4.4 Input current vs load

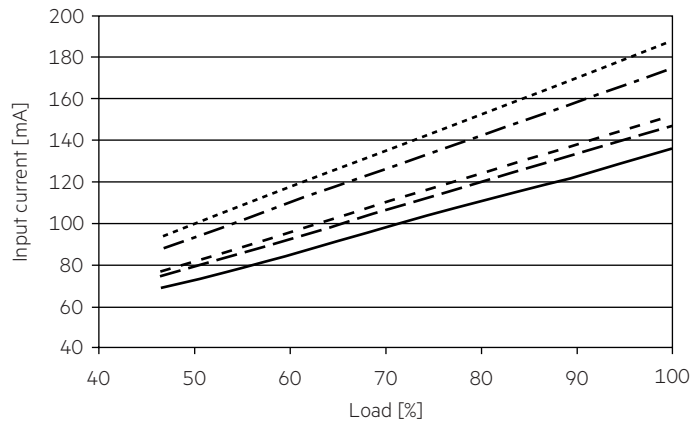

4.5 THD vs load

THD without harmonic < 5 mA (0.6 %) of the input current:

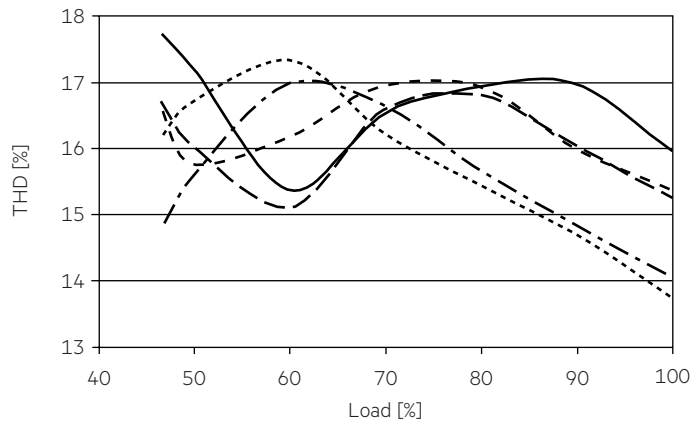

- 350 mA
- - - 375 mA
- - - 400 mA
- - - 450 mA
- - - 500 mA

4.6 Maximum loading of automatic circuit breakers in relation to inrush current

Automatic circuit breaker type	C10	C13	C16	C20	B10	B13	B16	B20	Inrush current
Installation Ø	1.5 mm ²	1.5 mm ²	1.5 mm ²	2.5 mm ²	1.5 mm ²	1.5 mm ²	1.5 mm ²	2.5 mm ²	I_{max} Time
LC 38W 350-500mA flexC Ip ADV	40	51	63	80	24	31	38	48	15 A 250 µs

This are max. values calculated out of inrush current! Please consider not to exceed the maximum rated continuous current of the circuit breaker. Calculation uses typical values from ABB series S200 as a reference. Actual values may differ due to used circuit breaker types and installation environment.

4.7 Harmonic distortion in the mains supply (at 230 V / 50 Hz and full load) in %

	THD	3.	5.	7.	9.	11.
LC 38W 350-500mA flexC Ip ADV	< 18	< 14	< 4	< 3	< 2	< 1

Acc. to 6100-3-2. Harmonics < 5 mA or < 0.6 % (whatever is greater) of the input current are not considered for calculation of THD.

5. Functions

5.1 Short-circuit behaviour

In case of a short circuit on the output side (LED) the LED Driver switches into hic-cup mode. After elimination of the short-circuit fault the LED Driver will recover automatically.

5.2 No-load operation

The LED Driver works in burst working mode to provide a constant output voltage regulation which allows the application to be able to work safely when LED string opens due to a failure.

5.3 Overload protection

If the output voltage range is exceeded the LED Driver will protect itself and LED may flicker. After elimination of the overload, the nominal operation is restored automatically.

5.4 DC emergency operation

The LED Driver is designed to operate on DC voltage and pulsed DC voltage. For a reliable operation, make sure that also in DC emergency operation the LED Driver is run within the specified conditions.

Light output level in DC operation (EOF_p): 100 % (cannot be adjusted)

The voltage-dependent input current of Driver incl. LED module is depending on the used load.

The nominal voltage-dependent no-load current of Driver (without or defect LED module) is for:

AC: < 18 mA

DC: < 5 mA

6. Miscellaneous

6.1 Insulation and electric strength testing of luminaires

Electronic devices can be damaged by high voltage. This has to be considered during the routine testing of the luminaires in production.

According to IEC 60598-1 Annex Q (informative only!) or ENEC 303-Annex A, each luminaire should be submitted to an insulation test with 500 V_{DC} for 1 second. This test voltage should be connected between the interconnected phase and neutral terminals and the earth terminal. The insulation resistance must be at least 2 MΩ.

As an alternative, IEC 60598-1 Annex Q describes a test of the electrical strength with 1500 V_{AC} (or 1.414 x 1500 V_{DC}). To avoid damage to the electronic devices this test must not be conducted.

6.2 Conditions of use and storage

Humidity: 5 % up to max. 85 %,
not condensed
(max. 56 days/year at 85 %)

Storage temperature: -40 °C up to max. +80 °C

The devices have to be within the specified temperature range (ta) before they can be operated.

6.3 Additional information

Additional technical information at www.tridonic.com → Technical Data

Guarantee conditions at www.tridonic.com → Services

Life-time declarations are informative and represent no warranty claim. No warranty if device was opened.