

BN 117 - DIN 934 - ~ISO 4032

Hexagon nuts ~0,8d

DIN 934
~ISO 4032
~UNI 5588

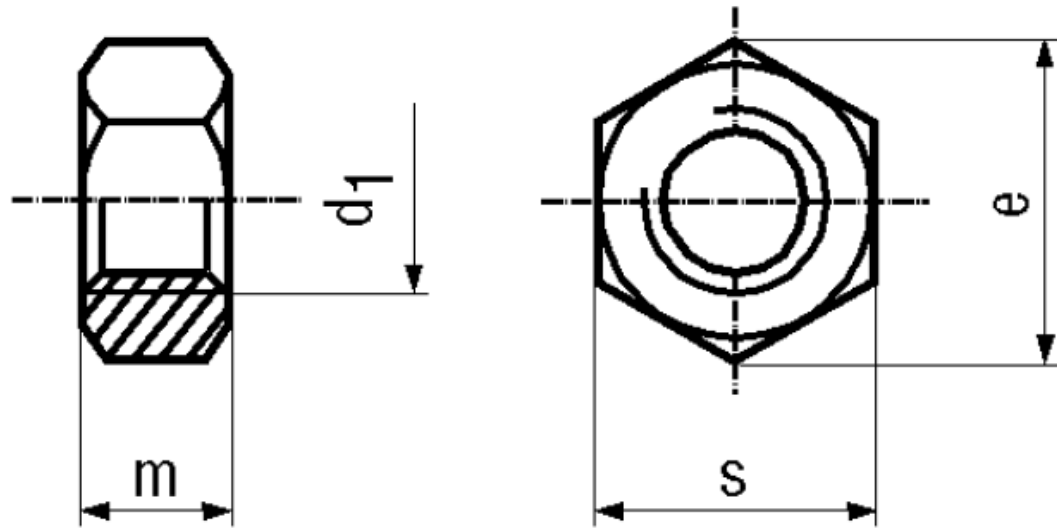

Material	Steel	Quality	cl. 8
Surface	zinc plated blue		

Article No. - 1874748

d_1	M6
e min.	11,05
s	10
m max.	5

DIN 934: Standard withdrawn
M10, M12, M14, M22: Wrench size according to ISO 272.