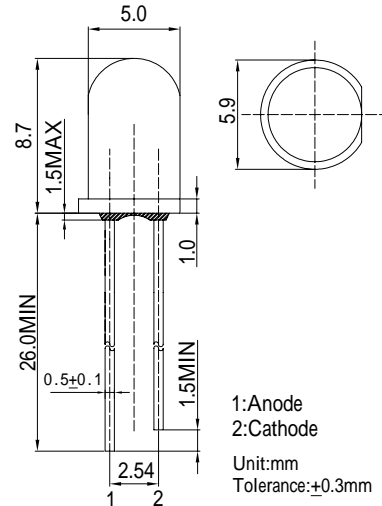

Features

- High Luminous LEDs
- 5mm Round Standard Directivity
- Superior Weather-resistance
- UV Resistant Epoxy
- Integral Current Limiting Resistor
- TTL Compatible (Requires No External Current Limiter With 12 Volt Supply)
- Cost Effective (Saves Space and Resistor Cost)
- Color Diffused Type

Applications

- Status Indicators
- Other Lighting

Outline Dimension

Absolute Maximum Rating (Ta=25 °C)

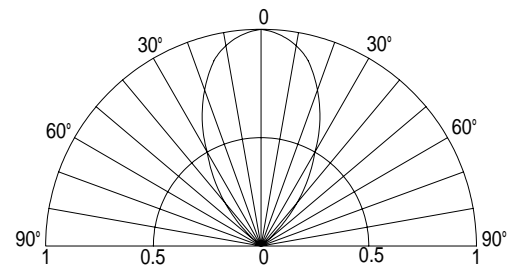
Item	Symbol	Value	Unit
DC Forward Voltage	V_F	15	V
Reverse Voltage	V_R	5	V
Power Dissipation	P_D	225	mW
Operating Temperature	T_{opr}	-30 ~ +85	
Storage Temperature	T_{stg}	-40 ~ +100	
Lead Soldering Temperature	T_{sol}	260 /5sec	-

Directivity

Electrical -Optical Characteristics (Ta=25 °C)

Item	Symbol	Condition	Min.	Typ.	Max.	Unit
DC Forward Current	I_F	$V_F = 12V$	-	10	15	mA
DC Reverse Current	I_R	$V_R = 12V$	-	-	10	μA
Domi. Wavelength*	λ_D	$V_F = 12V$	585	590	595	nm
Luminous Intensity*	I_v	$V_F = 12V$	100	130	-	mcd
50% Power Angle	$2\theta_{1/2}$	$V_F = 12V$	-	60	-	deg

*1 Tolerance of dominant wavelength is ± 1 nm

*2 Tolerance of luminous intensity is $\pm 15\%$

AlGaInP and Si Resistor LED
TYPICAL ELECTRICAL/OPTICAL CHARACTERISTIC CURVES
