

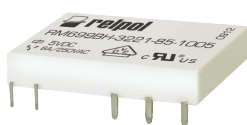

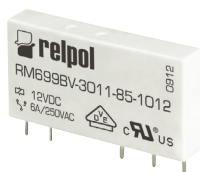

RM699B

miniature relays

Version (V)

Version (H)



- Cover width only 5,0 mm
- Sealed for soldering and cleaning
- **Terminals arrangement: vertical version (V) and horizontal version (H)**
- Applications: for PLC's, industrial machinery, time relays, counters, temperature adjusters, measurement instruments, office equipment, etc.
- Recognitions, certifications, directives: RoHS,    

Contact data

Number and type of contacts	1 CO	
Contact material	AgSnO₂	AgSnO ₂ /Au 3 μm ①
Max. switching voltage	400 V AC / 250 V DC	30 V AC / 36 V DC ①
Min. switching voltage	10 V	5 V
Rated load	AC1 DC1	6 A / 250 V AC 6 A / 24 V DC; 0,15 A / 250 V DC
Min. switching current	100 mA	10 mA
Max. inrush current	10 A 20 ms	0,1 A 20 ms ①
Rated current	6 A	0,05 A ①
Max. breaking capacity	AC1	1 500 VA 1,2 VA ①
Min. breaking capacity	1 W	0,05 W
Contact resistance	≤ 100 mΩ 100 mA, 24 V	≤ 30 mΩ 10 mA, 5 V
Max. operating frequency	AC1	360 cycles/hour 72 000 cycles/hour
• at rated load		
• no load		

Coil data

Rated voltage	DC	5 ... 60 V
Must release voltage		DC: ≥ 0,05 U _n
Operating range of supply voltage		see Table 1
Rated power consumption	DC	0,17 W 5 ... 24 V 0,217 W 48, 60 V

Insulation according to PN-EN 60664-1

Insulation rated voltage	250 V AC	
Overvoltage category	III	
Dielectric strength		
• between coil and contacts	4 000 V AC	type of insulation: reinforced
• contact clearance	1 000 V AC	type of clearance: micro-disconnection
Contact - coil distance		
• clearance	≥ 6 mm	
• creepage	≥ 8 mm	

General data

Operating / release time (typical values)	8 ms / 4 ms	
Electrical life (number of cycles)		
• resistive AC1	the NO and NC contact loaded (bilateral load): see Fig. 1 the NO contact loaded: > 3 x 10 ⁴ 6 A, 250 V AC	
Mechanical life (cycles)	> 10 ⁷	
Dimensions (L x W x H)	28 x 5 x 15 mm	
Weight	6 g	
Ambient temperature	• storage	-40...+85 °C
	• operating	-40...+85 °C
Cover protection category	IP 64	PN-EN 60529
Environmental protection	RTIII	PN-EN 116000-3
Shock resistance	5 g	
Vibration resistance	5 g 10...55 Hz	
Solder bath temperature	max. 260 °C	
Soldering time	max. 5 s	

The data in bold type pertain to the standard versions of the relays.

① For gold-plated contacts - when the maximum values given have been exceeded, the gold layer is destroyed. Then, the advantages of gold-plating disappear and the values are as for AgSnO₂ contacts (see beside), and electrical life of these contacts may be shorter than of normal contacts.

RM699B

miniature relays

Coil data - DC voltage version

Table 1

Coil code	Rated voltage V DC	Coil resistance at 20 °C Ω	Acceptable resistance	Coil operating range V DC	
				min. (at 20 °C)	max. (at 20 °C)
1005	5	147	$\pm 10\%$	3,75	7,5
1006	6	212	$\pm 10\%$	4,5	9,0
1009	9	476	$\pm 10\%$	6,75	13,0
1012	12	848	$\pm 10\%$	9,0	18,0
1024	24	3 390	$\pm 15\%$	18,0	36,0
1048	48	10 600	$\pm 15\%$	36,0	72,0
1060	60	20 500	$\pm 15\%$	45,0	90,0

Dimensions

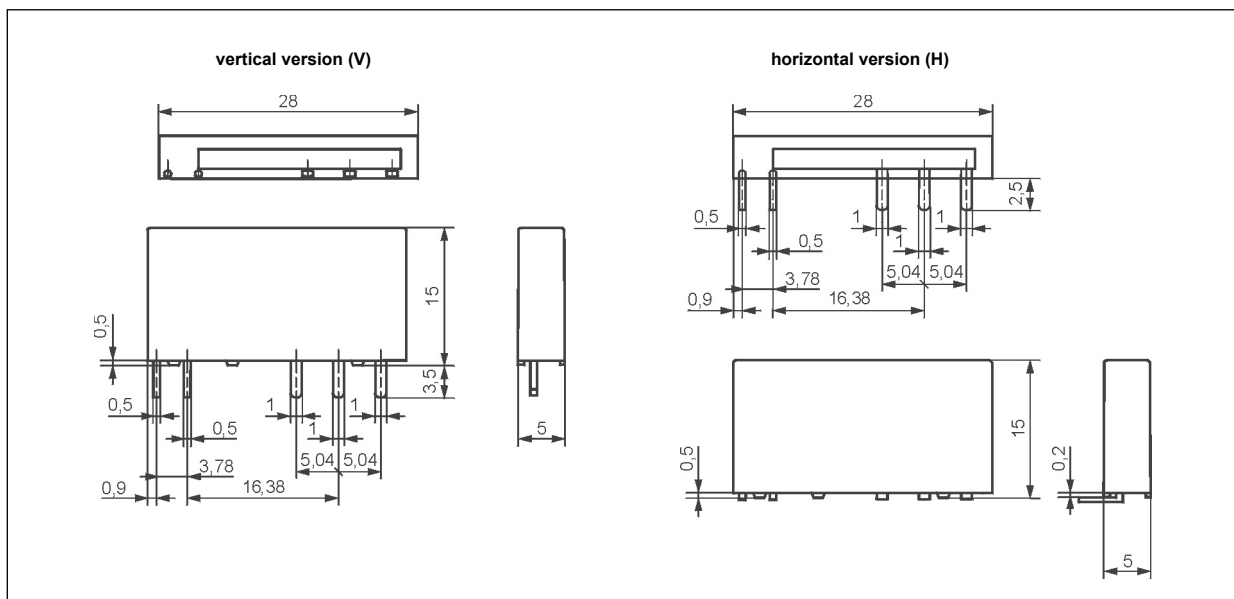

Connection diagrams (pin side view)



RM699B

miniature relays

Electrical life at AC resistive current.
Switching frequency: 360 cycles/hour

Fig. 1

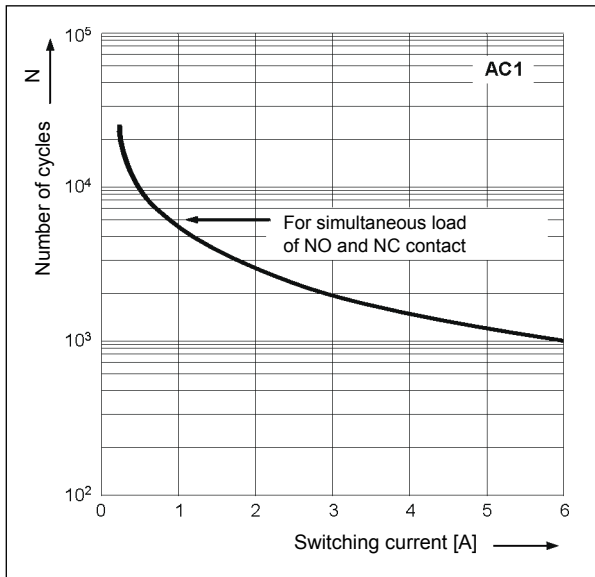

Max. DC resistive load breaking capacity

Fig. 2

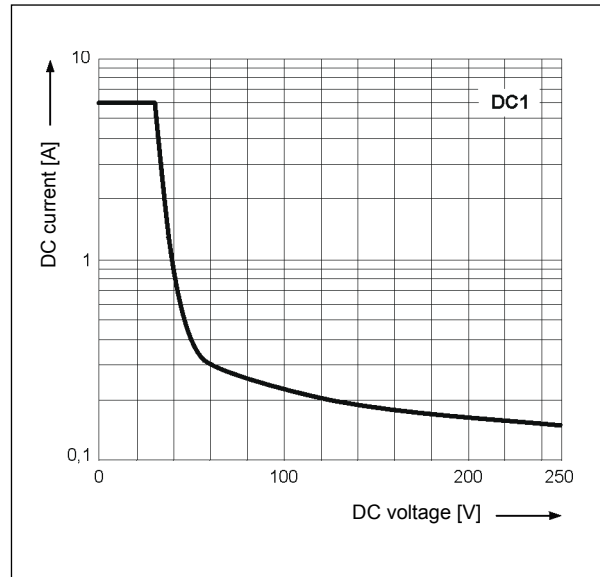

Coil operating range - DC

Fig. 3

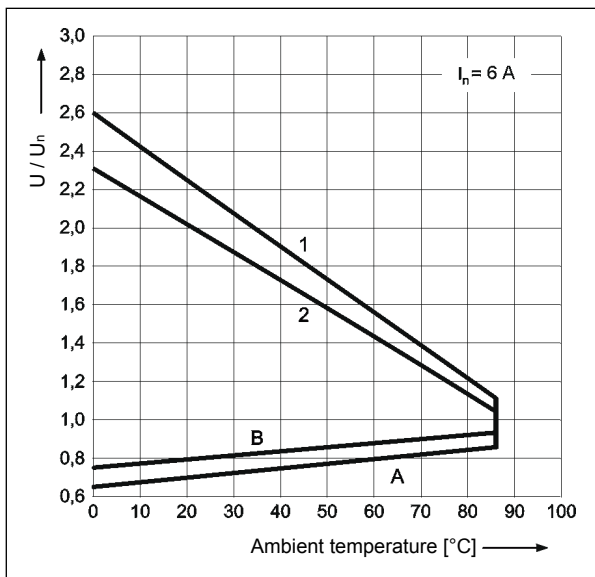

Description of Fig. 3

A - relations between make voltage and ambient temperature at no load on contacts. Coil temperature and ambient temperature are equal before coil energizing. Make voltage is not higher than the value read on Y axis (multiplication of rated voltage).

B - relations between make voltage and ambient temperature after initial coil heating up with $1,1 U_n$, at continues load of I_n on contacts. Make voltage is not higher than the value read on Y axis (multiplication of rated voltage).

1, 2 - values on Y axis represent allowed overvoltage on coil at certain ambient temperature and contact load:

1 - no load

2 - rated load

Mounting

Relays **RM699B vertical version (V)** are designed for:
• direct PCB mounting • sockets **PI6W-1P**, 35 mm rail mount acc. to PN-EN 60715 (see page 5).

Relays **RM699B horizontal version (H)** are designed for direct PCB mounting.

PI6W-1P

Plug-in sockets
for relays
RM699BV
or **RSR30**



RM699B

miniature relays

Pinout (solder side view)

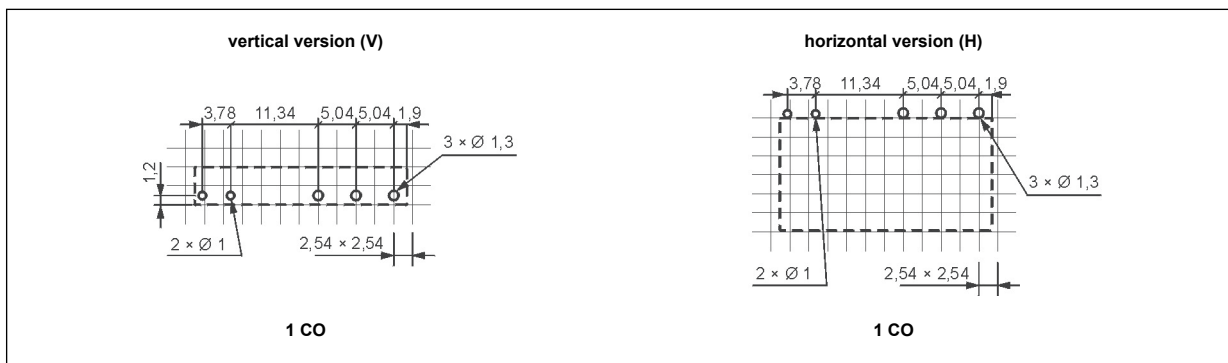

Ordering codes

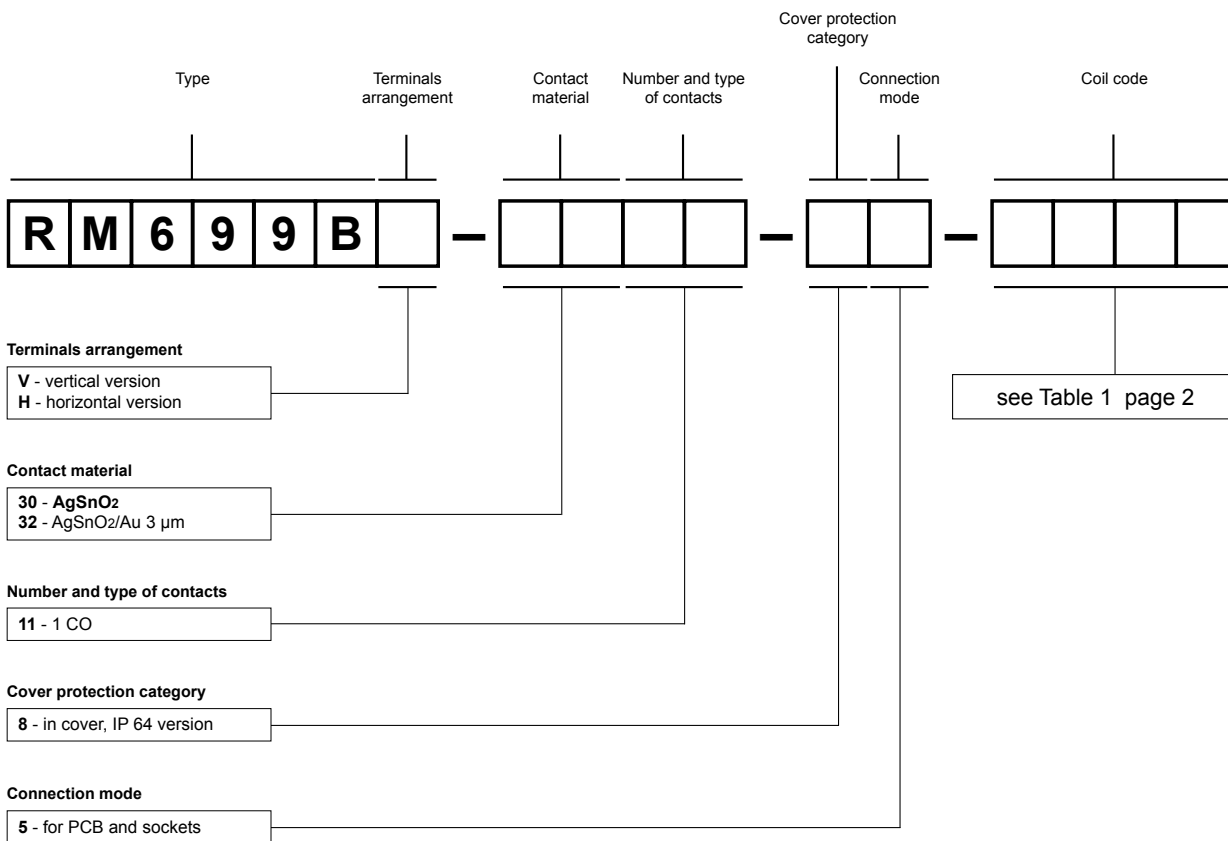

Examples of ordering code:

RM699BV-3011-85-1012

relay **RM699B**, vertical version, for PCB and sockets, one changeover contact, contact material AgSnO₂, coil voltage 12 V DC, in cover IP 64

RM699BH-3211-85-1005

Relais **RM699B**, horizontal version, for PCB, one changeover contact, contact material AgSnO₂/Au 3 μm, coil voltage 5 V DC, in cover IP 64

PI6W-1P

socket 6,2 mm

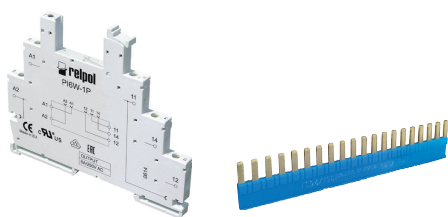

- Width 6,2 mm • Socket **PI6W-1P** without electronic
- Co-operate with relays: electromagnetic **RM699BV** or solid state **RSR30** ⓘ
- The input voltage complies with the voltage of the operational relay applied
- 35 mm rail mount acc. to PN-EN 60715
- May be linked with interconnection strip type **ZG20**
- Accessories: description plates **PI6W-1246**
- Recognitions, certifications, directives: RoHS,

Output circuit

Number and type of contacts / outputs	RM699BV: 1 CO	RSR30: 1 NO ⓘ
Max. voltage	400 V AC / 250 V DC	
Max. load	AC1	6 A / 250 V AC
Rated current	6 A	
Insulation according to PN-EN 60664-1		
Insulation rated voltage	250 V AC	
Rated surge voltage	4 000 V 1,2 / 50 µs	
Overvoltage category	III	
Insulation pollution degree	3	
Dielectric strength	• input - output	4 000 V AC 50/60 Hz, 1 min., type of insulation: reinforced
	• input - output	6 000 V 1,2 / 50 µs
Input - output distance	≥ 6 mm / ≥ 8 mm	
• clearance / creepage		
General data		
Dimensions (L x W x H)	98,5 x 6,2 x 85,5 mm	
Weight	40 g	
Ambient temperature	• storage	-40...+70 °C
	• operating	-40...+55 °C -40...+60 °C 12, 24 V DC
Protection category	IP 20	PN-EN 60529
Environmental protection	RTI	PN-EN 116000-3

Connection diagram

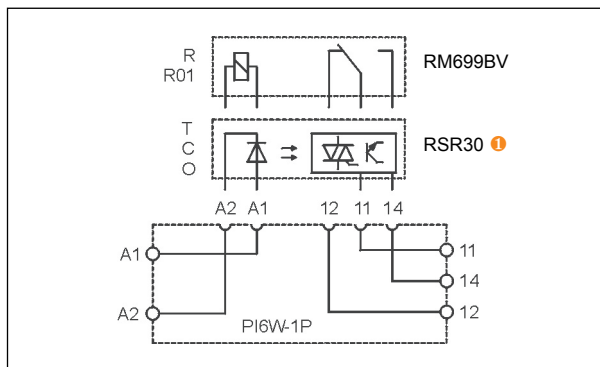

ⓘ Solid state relays type **RSR30** - see www.repol.com.pl

Ordering codes

Ordering codes: **PI6W-1P**.

Dimensions

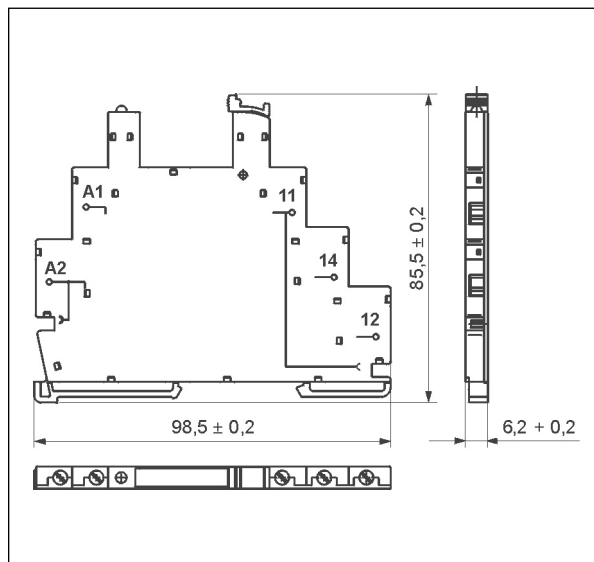

Mounting

Sockets **PI6W-1P** are designed for direct mounting on 35 mm rail mount acc. to PN-EN 60715. **Connections:** max. cross section of the cables: 1 x 2,5 mm² / 2 x 1,5 mm² (1 x 14 / 2 x 16 AWG), length of the cable deinsulation: 9 mm, max. tightening moment for the terminal: 0,3 Nm. **PI6W-1P** may be linked with interconnection strip type **ZG20**. Description plates of **PI6W-1246** type are offered for **PI6W-1P** sockets.

PRECAUTIONS:

1. Ensure that the parameters of the product described in its specification provide a safety margin for the appropriate operation of the device or system and never use the product in circumstances which exceed the parameters of the product. 2. Never touch any live parts of the device. 3. Ensure that the product has been connected correctly. An incorrect connection may cause malfunction, excessive heating or risk of fire. 4. In case of any risk of any serious material loss or death or injuries of humans or animals, the devices or systems shall be designed so to equip them with double safety system to guarantee their reliable operation.